

Kit 3057

BUICK Roadmaster, 5-dr Estate, 92-96

CHEVROLET Tahoe, 5-dr SUV, 00-06

CHRYSLER Town & Country, 5-dr MPV, 95-00, 01-05

CHRYSLER Voyager/Grand Voyager, 5-dr MPV, 95-00, 01-05

DODGE Caravan/Grand Caravan, 5-dr MPV, 95-00, 01-05

PLYMOUTH Voyager/Grand Voyager, 5-dr MPV, 95-00, 01-05

KIA Carnival, 5-dr MPV, 98-05

KIA Sedona, 5-dr MPV, 98-05

This Kit is only for vehicles with T-profile.

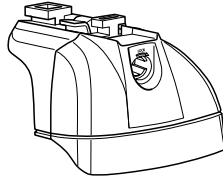

460R
753

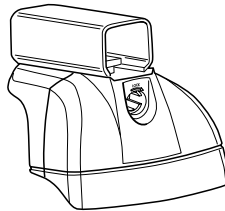

460

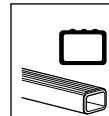

THULE[®]
SWEDEN

ISO 11154-E

Kit

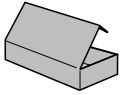

753

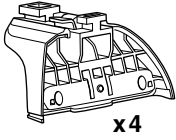

x4



x4



x4



x8

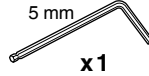

x1



x4



x1

460R

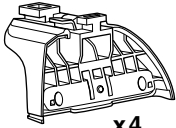

x4



x4



x4



x8

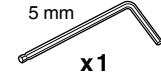

x1



x4

460

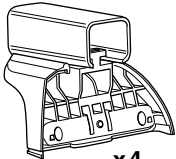

x4



x4



x4



x8

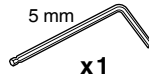

x1



x4

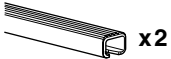
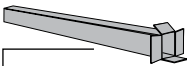

x2



x2

17 mm

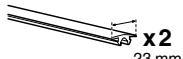

x2

23 mm



x2

23 mm

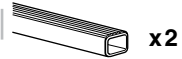

x2

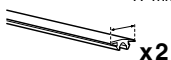

x2

23 mm

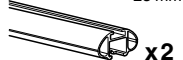

x2

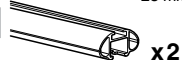

x2



x2



x4



x4



x4

1

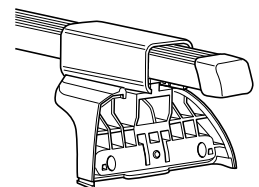
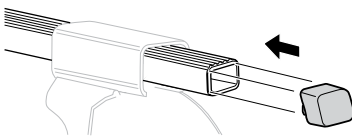
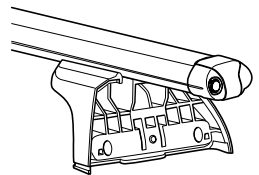
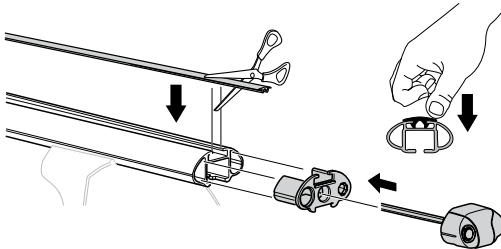
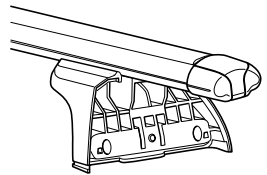
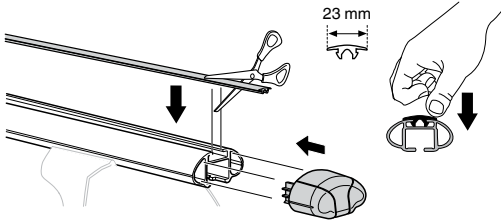
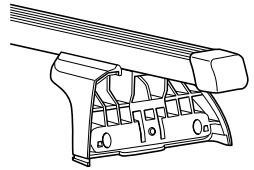
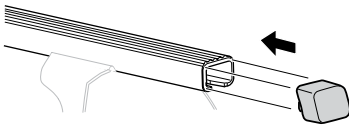
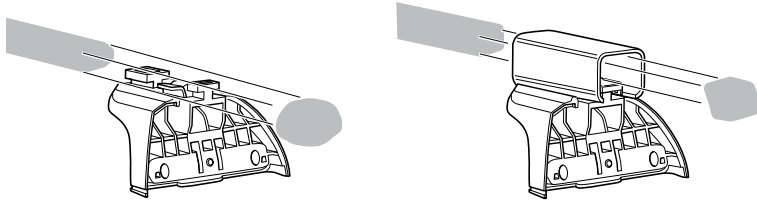
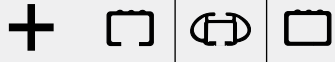
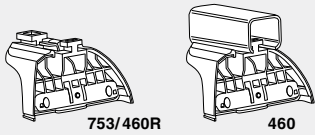

2

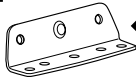

◀ 09 x 4



◀ 43 x 4



16 mm x 8



x 1

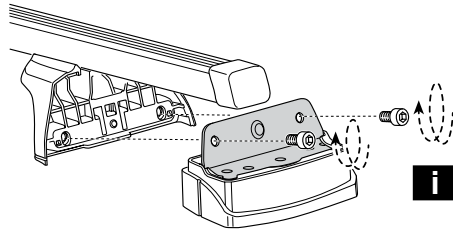
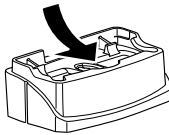
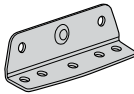
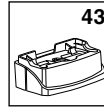
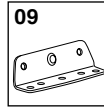
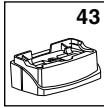
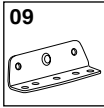
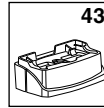
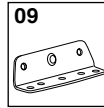
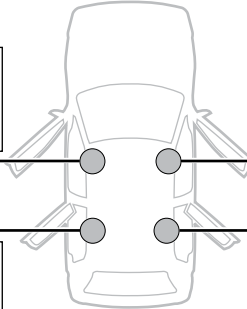
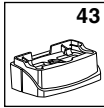
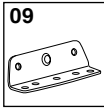

- GB** Only a few turns
- D** Nur wenige Umdrehungen
- F** Quelques tours uniquement
- NL** Slechts enkele slagen
- I** Solo qualche giro
- E** Sólo algunas vueltas
- PT** Noções básicas
- S** Endast några varv
- FIN** Vain muutama kierros

- EST** Ainult mõni pööre
- LAT** Tikai dažī apgriezieni
- LIT** Tik keli pasukimai
- PL** Wystarczy kilka obrotów
- RU** Достаточно нескольких оборотов
- CZ** Pouze několik otáčecí
- SK** Len niekoľko otáčok
- SLO** Le nekaj obratov

- HR** Samo nekoliko okreta
- HU** Csak néhány fordítás
- GR** Μόνο μερικές στροφές
- TR** Yalnız birkaç kez çevirm
- 中文** 只有几个转向
- 한국어** 두 세번만
- 日本語** 数回転のみ
- ไทย** หมุนเพียงไม่กี่รอบ

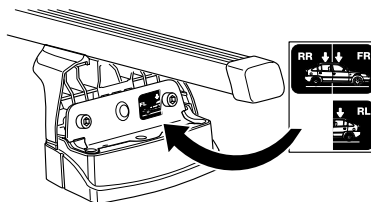

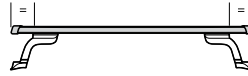
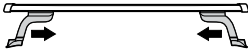
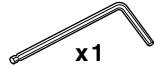
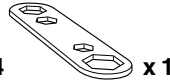
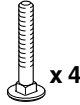
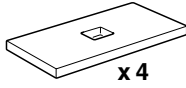
3

BUICK Roadmaster, 5-dr Estate, 92-96

CHRYSLER Town & Country, 5-dr MPV, 95-00, 01-05

CHRYSLER Voyager/Grand Voyager, 5-dr MPV, 95-00, 01-05

DODGE Caravan/Grand Caravan, 5-dr MPV, 95-00, 01-05

PLYMOUTH Voyager/Grand Voyager, 5-dr MPV, 95-00, 01-05

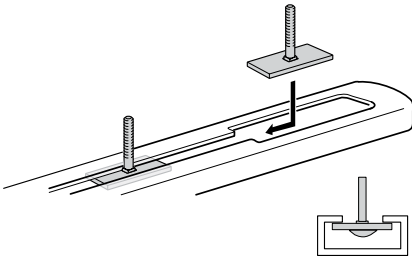
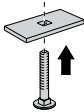
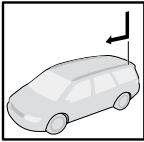

CHEVROLET Tahoe, 5-dr SUV, 00-06

KIA Carnival, 5-dr MPV, 98-05

KIA Sedona, 5-dr MPV, 98-05

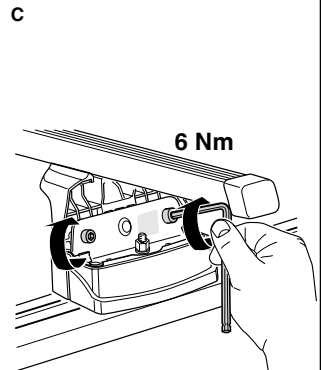
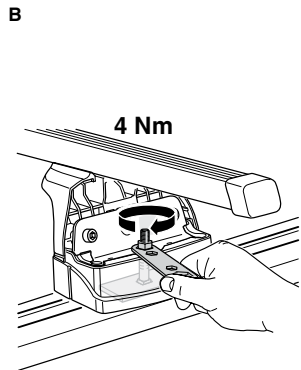
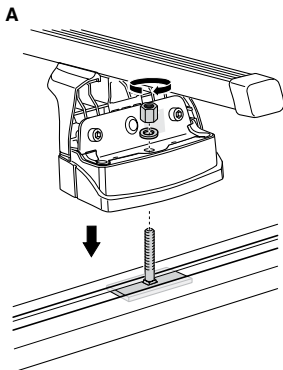
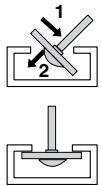
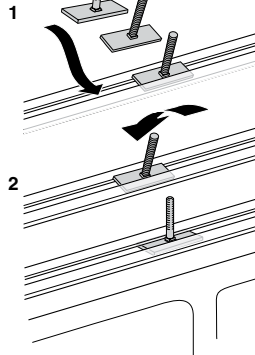
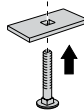
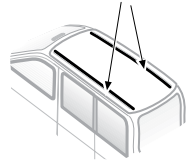

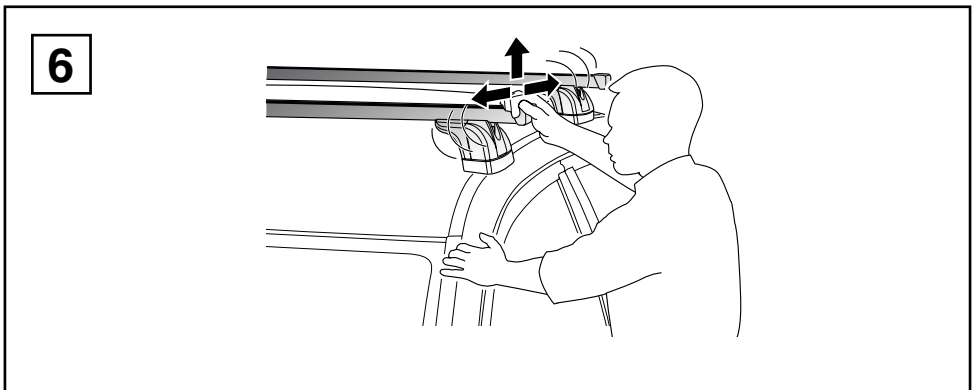
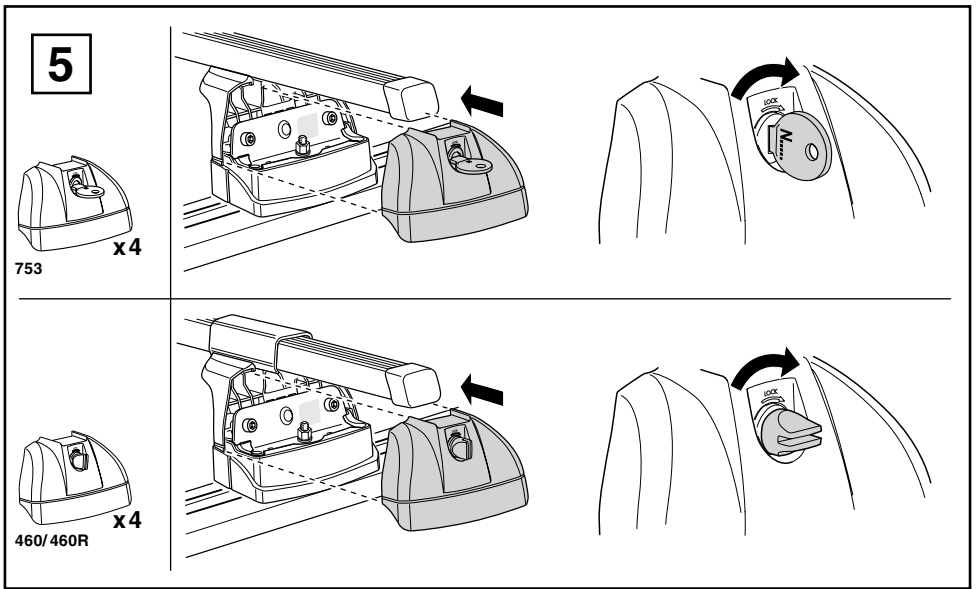
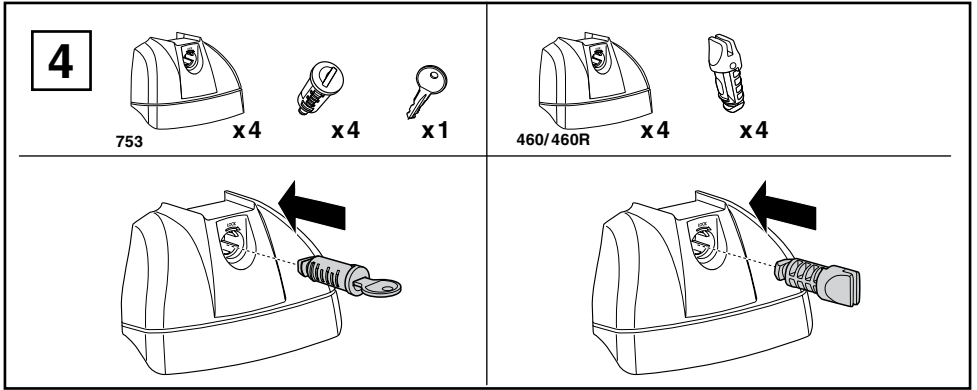

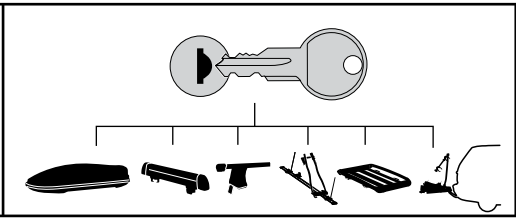
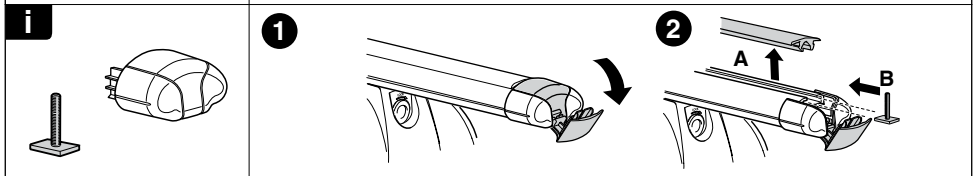
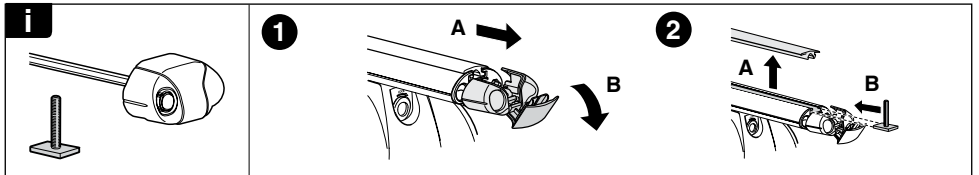
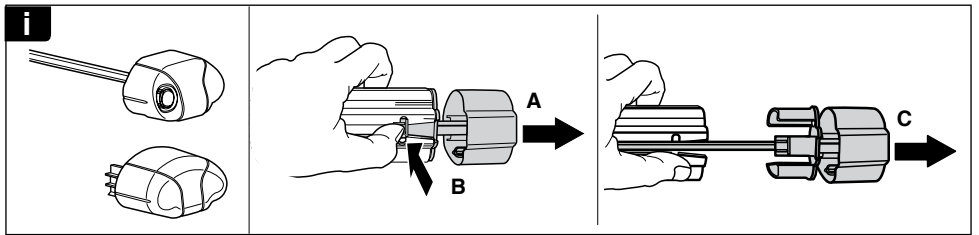
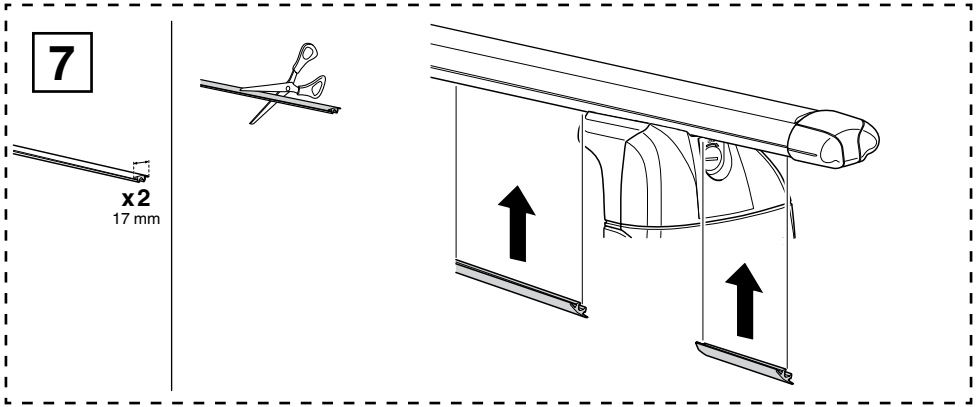

- 544 (x4)
- 596 (x6)
- 588 (x8)
- NA 510 (x10)
- EUR ASIA 452 (x12)

WW ▶ Thule Sweden AB, Box 69, 330 33 Hillerstorp, SWEDEN
 NA ▶ Thule Inc., 42 Silvermine Road, Seymour, Connecticut 06483, USA

info@thule.com
 customer.service@thule.com

www.thule.com