



Thule XT Kit 3068

> Instructions

HYUNDAI Accent, 5-dr Hatchback, 12-17

HYUNDAI i20 (Mk.II.), 5-dr Hatchback, 15-

HYUNDAI i25, 5-dr Hatchback, 12-

HYUNDAI Solaris, 5-dr Hatchback, 12-

HYUNDAI Verna, 5-dr Hatchback, 12-

SUBARU Impreza (Mk.III.), 4-dr Sedan, 07-11

SUBARU Impreza (Mk.III./IV.), 5-dr Hatchback, 07-11, 12-16

SUBARU Impreza / WRX, 4-dr Sedan, *08-11

SUBARU Impreza / STI / WRX, 5-dr Hatchback, *08-11, 12-16

SUBARU XV, 5-dr SUV, 12-17

*North America

This kit is only for vehicles with fixpoint mounting.

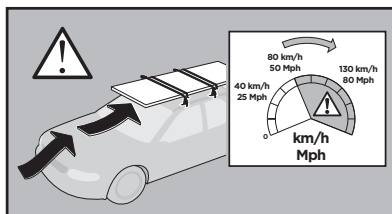
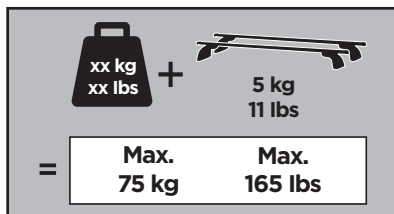
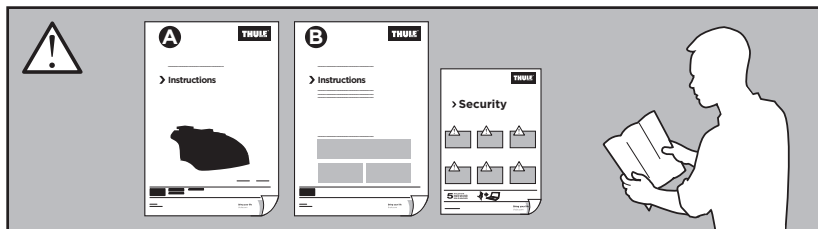

ISO 11154-E

183068

C.20181211
509-3068-08

Bring your life

thule.com

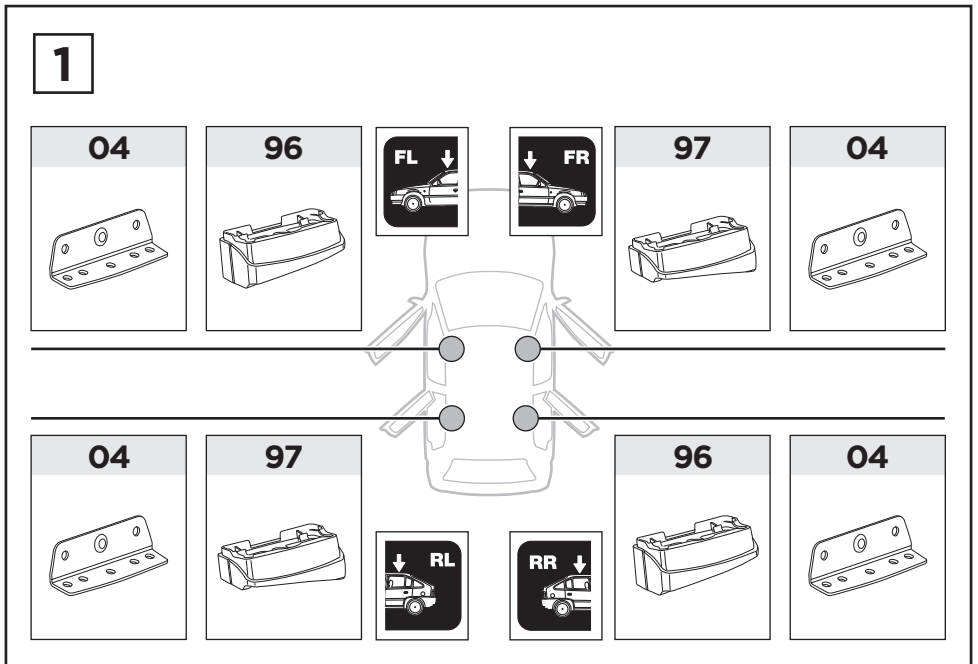
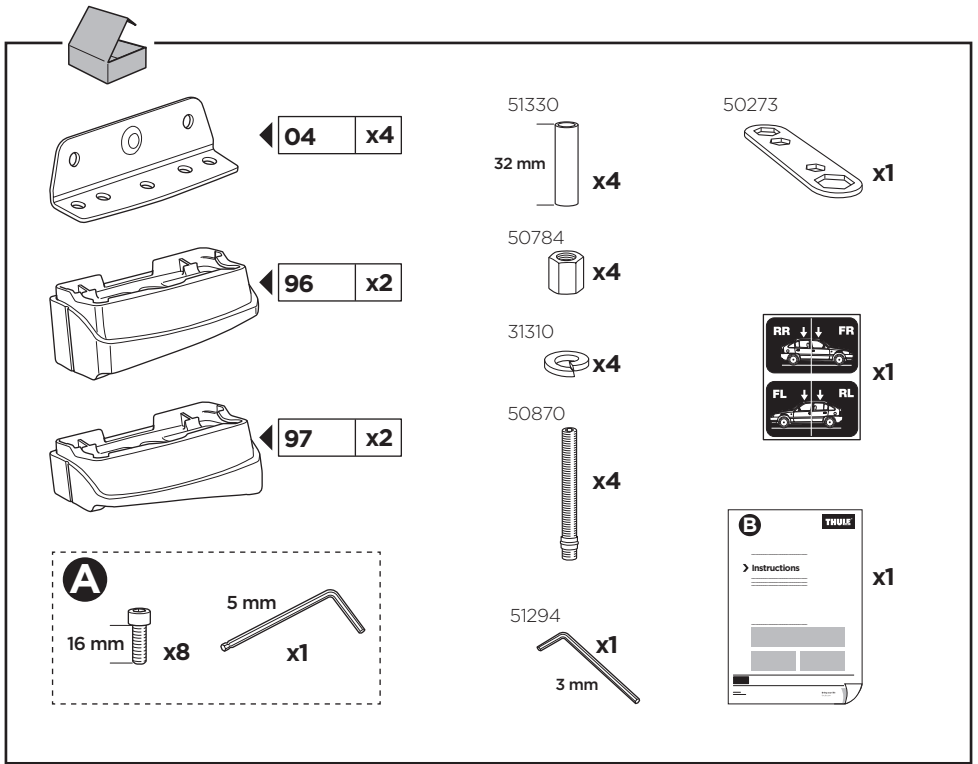

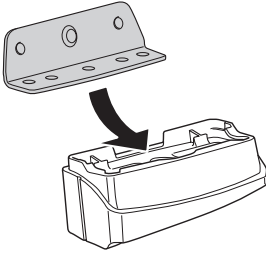
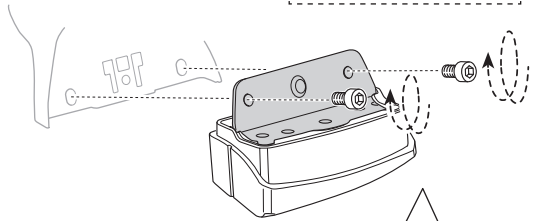
2**A****B**

- EN** Only a few turns
- DE** Nur wenige Umdrehungen
- FR** Quelques tours uniquement
- NL** Slechts enkele slagen
- IT** Solo qualche giro
- ES** Sólo algunas vueltas
- PT** Noções básicas
- SV** Endast några varv
- DK** Kun nogle få omgange
- NE** Bare noen få omdreinger
- FI** Vain muutama kierros
- ET** Ainult mõni pööre
- LV** Tikai dažī apgriezieni
- LT** Tik keli pasukimai
- PL** Wystarczy kilka obrotów
- RU** Только несколько оборотов

- UK** Лише декілька обертів
- BG** Само няколко завъртания
- CS** Pouze několik otáček
- SK** Len niekoľko otáčok
- SL** Le nekaj obratov
- HR/BiH** Samo nekoliko okreta
- RO** Doar câteva rotiri
- HU** Csak néhány fordítás
- EL** Μόνο λίγες περιστροφές
- TR** Yalnızca birkaç tur

بعض دورات فقط

AR

רק מספר סיבובים

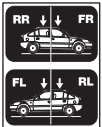
HE**ZH** 仅几圈**JA** 2～3回転のみ**KO** 몇 번만 돌리면 됨**TH** □□□□□□□□□□□□□□**3**

x1

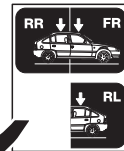
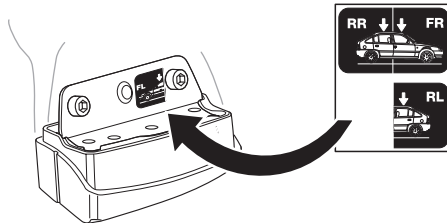

4

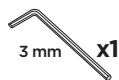

A

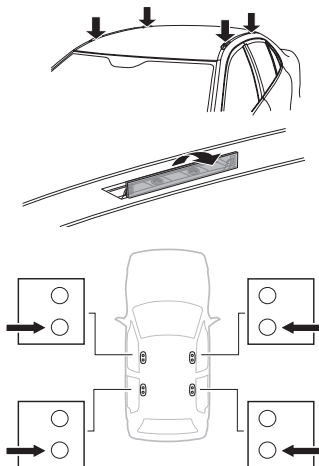

B

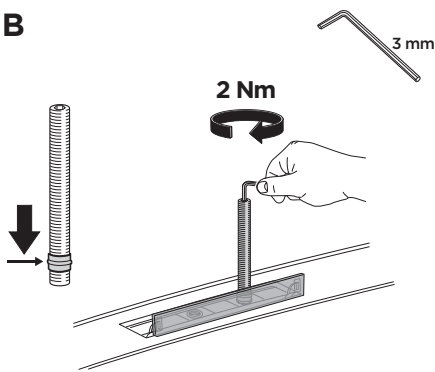

D

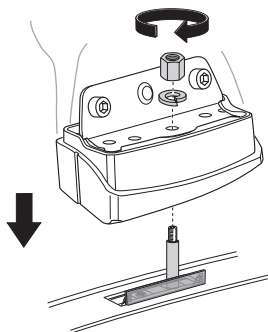

C

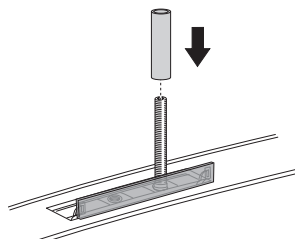

5

A

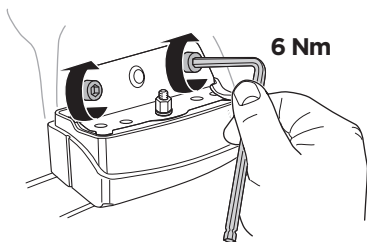
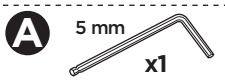

B

