



THULE
SWEDEN

Thule XT Kit 3072

> Instructions

CITROËN Berlingo, 4-dr Van, 08-
CITROËN Berlingo, 5-dr Van, 08-
PEUGEOT Partner, 4-dr Van, 08-
PEUGEOT Partner, 5-dr Van, 08-

This kit is only for vehicles with fixpoint mounting.

Contents:

- Instructions 751 FootPack
- Instructions 753 FootPack
- Instructions
- Security

Weight Limits:

- xx kg / xx lbs + 6 kg / 13 lbs = Max. 100 kg / 220 lbs
- xx kg / xx lbs + 9 kg / 20 lbs = Max. 150 kg / 330 lbs

Vehicle Compatibility:

- 80 km/h / 50 Mph
- 130 km/h / 80 Mph
- 40 km/h / 25 Mph

ISO 11154-E

183072

C.20130612
509-3072-01

Bring your life
thule.com

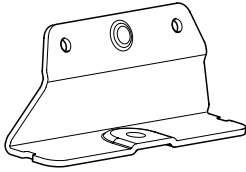

◀ 02 x4

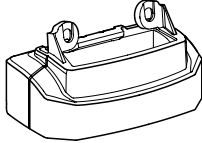

◀ 29 x4

50997

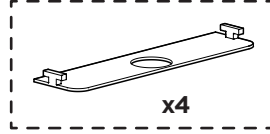

x4

50995

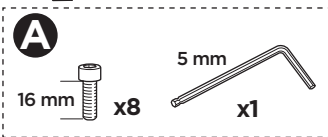
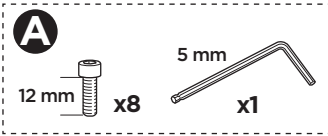
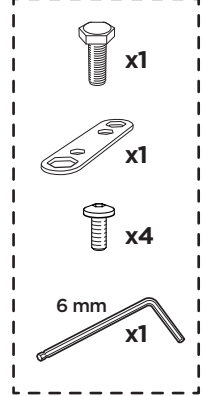

x1

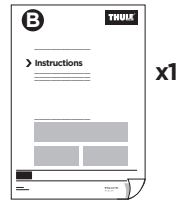

x1

1

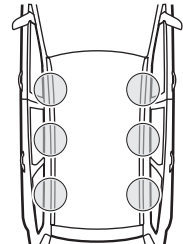
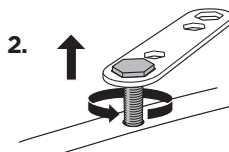
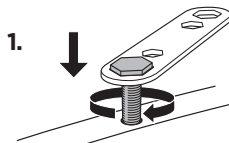
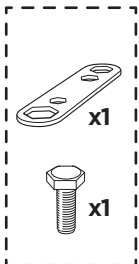

2

751 FootPack

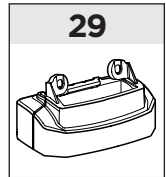
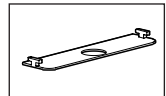
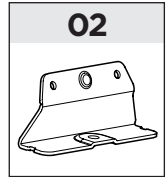
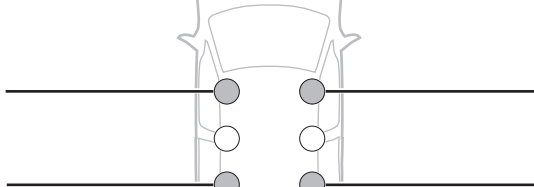
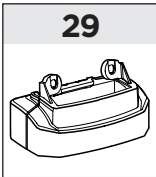
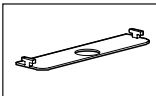
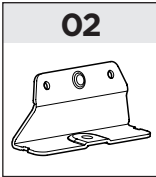
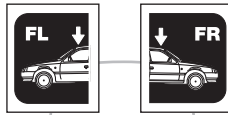
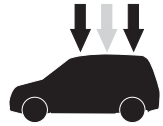

753 FootPack

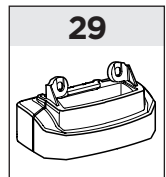
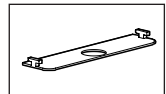
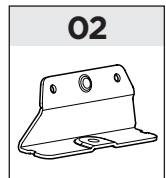
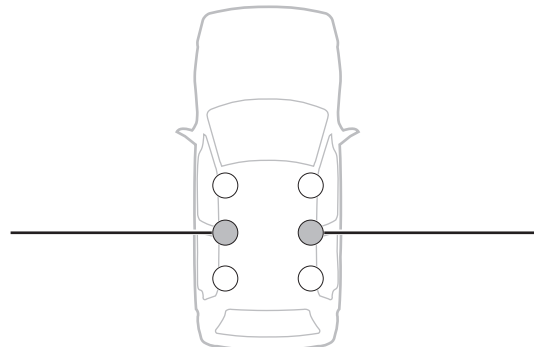
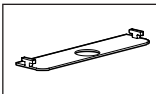
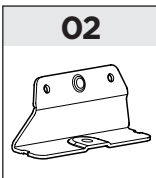
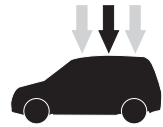

3



751
FootPack

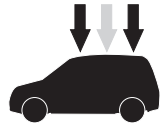

A

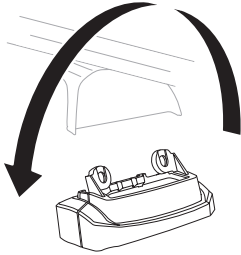

B

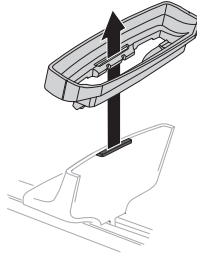

C

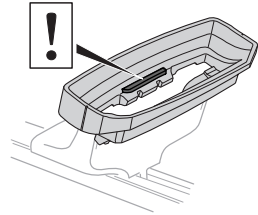

D

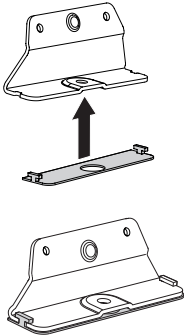

E

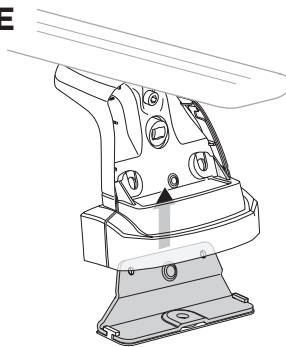

F

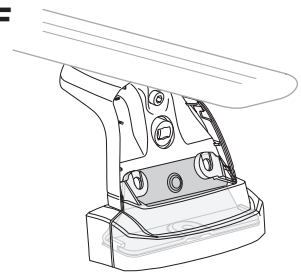

G

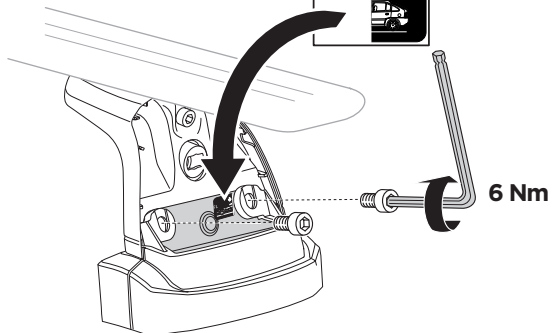
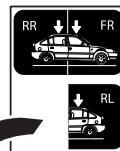
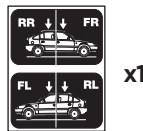
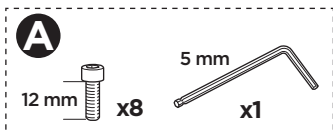

3 753 FootPack

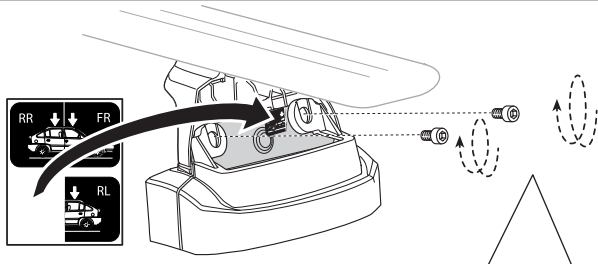
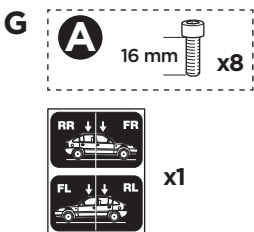
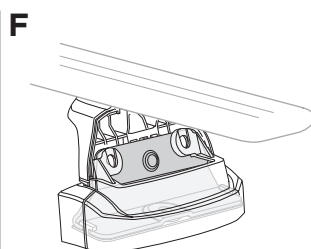
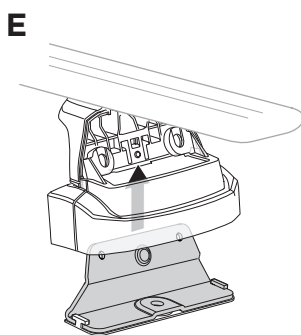
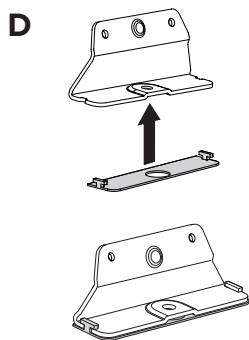
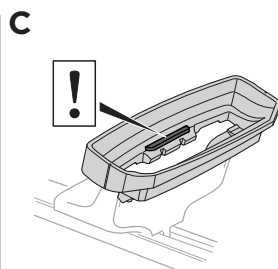
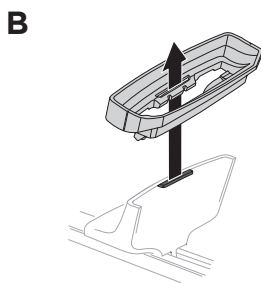
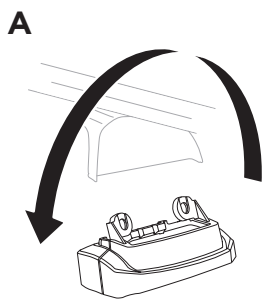
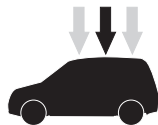

EN Only a few turns
DE Nur wenige Umdrehungen
FR Quelques tours uniquement
NL Slechts enkele slagen
IT Solo qualche giro
ES Sólo algunas vueltas
PT Noções básicas
SV Endast några varv
DK Kun nogle få omgange
NE Bare noen få omdreinger
FI Vain muutama kierros

ET Ainult mõni pööre
LV Tikai dažī apgriezieni
LT Tik keli pasukimai
PL Wystarczy kilka obrotów
RU Только несколько оборотов
UK Лише декілька обертів
BG Само няколко завъртания
CS Pouze několik otáček
SK Len niekoľko otáčok
SL Le nekaj obratov
HR/BIH Samo nekoliko okreta

RO Doar câteva rotiri
HU Csak néhány fordítás
EL Μόνο λίγες περιστροφές
TR Yalnızca birkaç tur

بعض دورات فقط **AR**
 רק מספר סיבובים **HE**
ZH 仅几圈
JA 2～3回転のみ
KO 몇 번만 돌리면 됨
TH เพียงสองสามรอบ

2



751
FootPack

A

5 mm

x1



x4

6 mm

x1

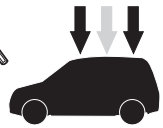

A

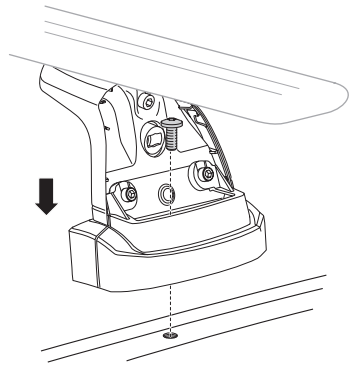
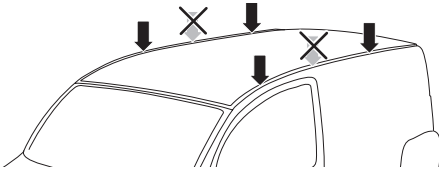

B

6 mm

x1

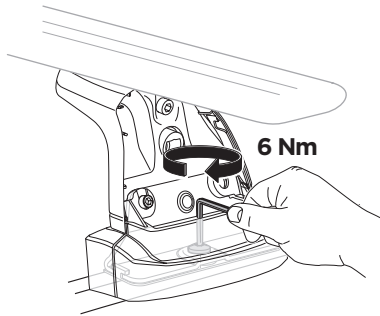

6 Nm

C

A

5 mm

x1

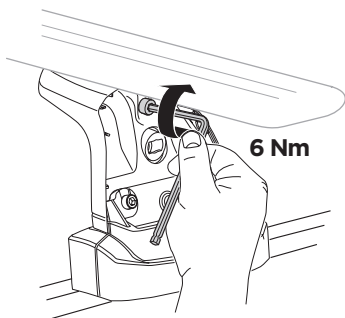

6 Nm



2

753
FootPack

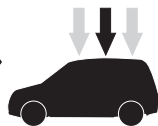
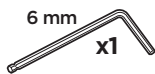
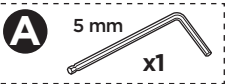

A

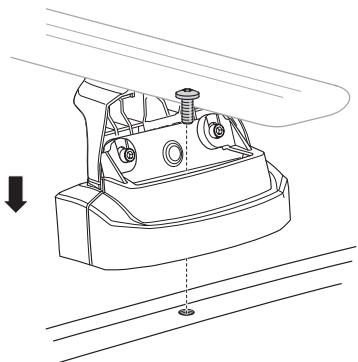
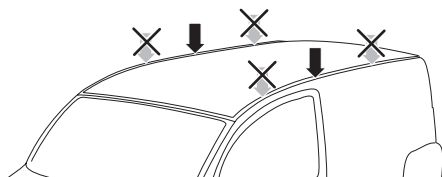

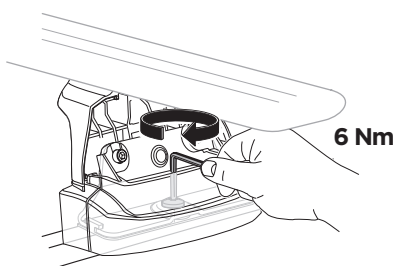
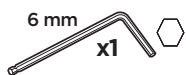

B

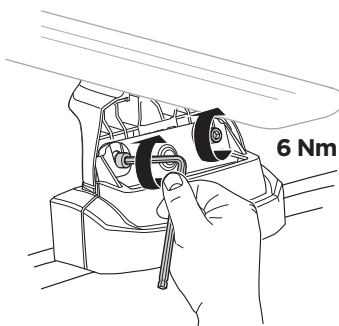
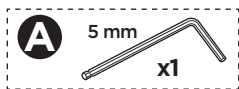

C



WW ▶  Thule Sweden AB, Box 69, 330 33 Hillerstorp, SWEDEN
NA ▶  Thule Inc., 42 Silvermine Road, Seymour, Connecticut 06483, USA

 info@thule.com
 Phone: 800-238-2388

 www.thule.com

› PART OF THULE GROUP

509-3072-01